

V-TUF

RAPID VTS HPC

ELECTRIC INDUSTRIAL
MOBILE STAINLESS STEEL
HOT WATER PRESURE WASHER



User Operating Manual



Thank you for purchasing a V-TÜF Rapid VTS Industrial Hot Water Pressure Washer.

Please register your product online: at
v-tuf.com – customer tools – register your product



Country / Language	Page	Note:
English	3 – 4	These instructions MUST be read before operating this machine.
العربية (Arabic)	5 – 6	يجب قراءة هذه التعليمات قبل تشغيل هذا الجهاز.
Български (Bulgarian)	7 – 8	Тези инструкции трябва да се четат преди да оперират на тази машина.
Català (Catalan)	9 – 10	Cal llegir aquestes instruccions abans de funcionament d'aquesta màquina.
Čeština (Czech)	11 – 12	Tyto pokyny musí přečíst před strojem.
Dansk (Danish)	13 – 14	Disse instruktioner skal læses inden opererer denne maskine.
Nederlands (Dutch)	14 – 16	Deze instructies moeten worden gelezen voor deze machine.
Eesti (Estonian)	17 – 18	Neid juhiseid tuleb lugeda enne seadme see masin.
Suomi (Finnish)	19 – 20	Nämä ohjeet luettava ennen käyttöä tässä koneessa.
Français (French)	21 – 22	Ces instructions doivent être lues avant d'utiliser cette machine.
Deutsch (German)	23 – 24	Diese Anweisungen müssen gelesen werden, bevor diese Maschine in Betrieb.
Ελληνικά (Greek)	25 – 26	Αυτές οι οδηγίες πρέπει να διαβάζονται πριν θέσετε σε λειτουργία αυτό το μηχάνημα.
Indonesia (Indonesian)	27 – 28	Petunjuk ini harus dibaca sebelum operasi mesin ini.
Italiano (Italy)	29 – 30	DEVONO leggere queste istruzioni prima di usare questa macchina.
日本語 (Japanese)	31 – 32	これらの指示は、この機械を操作する前に読み取る必要があります。
한국어 (Korean)	33 – 34	이 기계를 작동 하기 전에이 지침을 읽어야 합니다.
Latviešu (Latvian)	35 – 36	Šie norādījumi ir jāizlasa, pirms šī darbināšana.
Lietuvių (Lithuanian)	37 – 38	Šios instrukcijos turi būti skaitomas prieš skrendant šį mašiną.
Norsk (Norwegian)	39 – 40	Disse instruksjonene må leses før denne maskinen.
Polski (Polish)	41 – 42	Te instrukcje należy przeczytać przed przystąpieniem do eksploatacji maszyny.
Português (Portuguese)	43 – 44	Estas instruções devem ser lidas antes de operar esta máquina.
Română (Romanian)	45 – 46	Aceste instrucțiuni trebuie să citiți înainte de această mașină de operare.
Русский (Russian)	47 – 48	Эти инструкции должны прочитать перед началом эксплуатации этой машины.
Slovenčina (Slovak)	49 – 50	Tieto pokyny musia čítať pred prvým tohto stroja.
Slovenščina (Slovenian)	51 – 52	Ta navodila mora prebrati pred razporeditvijo ta stroj.
Español (Spanish)	53 – 54	Estas instrucciones deben leerse antes de operar esta máquina.
Svenska (Swedish)	55 – 56	Dessa instruktioner måste läsas innan du använder denna maskin.
ไทย (Thai)	57 – 58	คำแนะนำเหล่านี้ต้องอ่านก่อนใช้งานเครื่องนี้
Türkçe (Turkish)	59 – 60	Bu makineyi çalıştırmadan önce bu talimatları okuyun gerekir.
Українська (Ukrainian)	61 – 62	Перед початком виконання функцій цього комп'ютера повинен прочитати ці інструкції.
Việt Nam (Vietnamese)	63 – 64	Những hướng dẫn này phải được hiểu trước khi hoạt động máy tính này.

Contents

Contents	Page
Important Safety Instructions	5
General Points & Information	6
Safety Norms & Usage	7-9
Technical Data	10
Identification Data	11
Installation	12
Cold & Hot Water Use	13
Important Advice	15
Transport / Lifting / Storing	16-17
Regulation of Start Electrodes	18
Troubleshooting	19-22
Electric Diagrams	24-26
Functionality	26-27
Pump & Motor Parts Diagram & Parts List	28
Frame Parts Diagram & Parts List	29
Boiler Parts Diagram & Parts List	30-32
Electric Box Parts Diagram & Parts List	33-34
Accessories Parts Diagram & Parts List	35
XHDM300/XHDM350/XHDM400 Pump Parts Diagram	36-38

Important Safety Instructions

**This book has important information for the use and safe operation of this machine.
Read and understand all warnings before you start working.**

IDENTIFICATION LABEL

Before using this machine, make sure that it is provided with the identification Label. In case the identification Label is missing, do not use the machine and consult your dealer immediately.

The Identification Label with the technical specifications is fixed to the Chassis on the rear of the electrical enclosure inside the cabinet

Check that your mains voltage is the same as shown on the identification label.



WHEN USING THIS MACHINE, PLEASE FOLLOW THESE BASIC PRECAUTIONS



1. Read and understand all the instructions before using the machine.
2. Know how to stop the machine and release pressure quickly, be familiar with all the controls.
3. The jet must not be directed at persons, animals, live electrical equipment or the appliance itself.
4. Do not direct the jet against yourself or others in order to clean clothes or foot-wear.
5. Disconnect from the electrical power supply before carrying out user maintenance.
6. High pressure cleaners must not be used by children or untrained personnel.
7. High pressure hoses, fittings and couplings are important for the safety of the appliance. Use only hoses, fittings and couplings recommended by the V-TUF.
8. Always wear suitable eye, face and body protection.
9. Do not operate the machine when fatigued or under the influence of alcohol or drugs.
10. Keep operating area clear of all persons.
11. Do not overreach or stand on any unstable ground, keep good footing and balance at all times.
12. Follow the maintenance instructions specified in the manual.
13. Read carefully instructions concerning grounding (Earthing) and extension cables.
14. To prevent fire hazard, do not use with or near inflammable substances such as: petrol, solvents or thinners.

This manual should be considered a permanent part of the machine and should remain with it if ownership is transferred.

Save These Instructions in a Safe Place

General Points

Instruction Manual

Please check that the manual is in good condition and that each of the pages are clearly legible. Should the manual be damaged, or missing any pages, please return it immediately to your re-seller who will provide you with a replacement copy. Alternatively, you can download this document as a pdf from the website at v-tuf.com and search for this Rapid-VTS Industrial Stainless Hot Water Pressure Washer.

Conservation of the Manual

This manual should be retained for the full working life of the machine. In case of loss or damage, please request a copy from V-TUF, quoting type of machine, matriculation number and the year of manufacture.

Trial before shipment

The machine has been tested at the manufacturer's factory to check that all of the components are functioning correctly according to the machine's specifications.

Guarantee Terms

The machine is under guarantee according to agreed contractual terms which constitute an integral part of the order or the rules in force, in all cases, for a maximum period equivalent to twelve (12) months from the date of dispatch from the factory. The guarantee covers exclusively breakages which could be due to defective mechanics or assembly. The guarantee does not cover parts subject to wear and tear. The guarantee is considered forfeit in the following cases:

1. Improper use of the machine, failure to observe the rules of use,
2. Use of non-original parts, those not sold directly by the manufacturer or an authorised re-seller,
3. Modifications made to the machine, or repairs made to the machine by anyone not specifically authorised by the manufacturer or by the re-seller.

Packaging

The packing materials and any parts replaced during maintenance should be collected and sent to a specialist waste disposal firm (wood, plastic, metal etc.) and not left within the reach of children or animals.

Delivery

The transport will be carried out by qualified companies, in respect to regulations in force and legislation relative to weight and length. The merchandise travels under the full responsibility of the transporter and the user; in the event of an accident, or late delivery, the manufacturer accepts no liability.

Checks

Upon receipt of the goods, check the condition that they are in. Should they appear damaged, avoid any type of installation and immediately advise the transporter and the supplier.

To ascertain the condition of the parcel, proceed to unpack the goods and check that the delivery is complete (check the correspondence with the delivery note), ascertain whether the machine has arrived in generally good condition, free of breakages or dents. In the event of missing or damaged items, immediately advise the re-seller and / or the manufacturer after having reported these when signing the transporter's delivery note.

Personal identifying data

An exact description of the model, serial number and installed accessories will aid a quick and efficient response on the part of the manufacturer or help centre. Always provide the type, model of machine and its serial number each time you contact the help centre. To help you remember, we suggest that you place the relevant machine details in the panel below:

Model	Serial N°
Year of manufacture	Type of pump

Type of motor

Prior to use, please carefully read the instructions, paying particular attention to "IMPORTANT RECOMMENDATIONS", "SECURITY NORMS" and "PRECAUTIONS".

It is forbidden to remove or tamper with the protective parts of the machine.

It is forbidden to use inflammable, explosive or toxic substances.

It is obligatory to use appropriate protective equipment.

It is obligatory to keep the machine clean and in good working order, in particular the controls, the connections and the technical data panel.

For your safety, and that of those around you, and for the continued working of the machine, do not use parts other than those prescribed by the constructor.

Before using the high pressure cleaner, always try to ensure that any potential hazardous conditions have been removed or eliminated from the area of usage.

The high pressure cleaner should be used with clean water. Unfiltered water and/or corrosive chemicals will cause damage to the machine.

IMPORTANT RECOMMENDATIONS

The ordinary use of this machine does not require particularly specialised training, as long as the user has sufficient competence and training to carry it out, knowledge of this manual and is aware of general safety procedures.

Follow the instructions with great care for your safety and that of others, to safeguard your machine and protect the environment.

SECURITY NORMS

FOUR SYMBOLS TO REMEMBER



General danger

Your machine is supplied with electronic apparatus, the use of which requires the observation of the following safety criteria.



Ranger of severe damage to the machine



Danger to people



Safeguarding the environment



When using the machine outdoors, do not use when it is raining



Take great care not to damage the electrical power supply lead, in case in spite of taking precautions the cable is damaged do not attempt a precarious repair. A new cable costs much less than having to repair the machine due to an eventual power fault, let alone the danger a defective cable could pose for people and animals.



Do not attempt any kind of maintenance whilst the plug is connected to any sort of power supply.





Take care not to spray the machine with the water jet as this could lead to short-circuit





Should you need to use an extension lead with the power supply, make sure that the connection between the extension lead and the power lead is secure and stable and conforms to standard safety norms. The plug and the socket should be waterproof.

 Do not use the electric plug to turn the machine on or off. Always use the appropriate switches on the machine.

 Keep the machine out of reach of children or unauthorised personnel and ensure that no-one else is able to reach the machine when it is connected to a live electric current.

 It is strictly forbidden for the user to operate the machine in any way in bare feet.

 Do not use the machine if any of its components are defective.

 Do not use the machine if there are people in your way.

 Do not direct the water flow near sources of electricity.

 Do not place your hands ahead of the lance; high pressure nozzles can be extremely dangerous when used inappropriately.

 If the machine should be used in service stations, supply stations or other potentially dangerous locations, please ensure that the appropriate safety procedures are observed.

 Do not touch the motor, the chimney the boiler or other internal parts when the machine is on, or immediately after it has been turned off as you may risk burning or scalding.

 Should you need to clean the motor, this procedure should be carried out in places where, to safeguard the environment, an adequate oil separator is installed.

 Re-filling of petrol should only be undertaken when the machine is turned off

 Do not use combustible materials other than those advised by the constructor.

 Once you have finished working, and after the machine has stopped, release the residual pressure in the tube and pump by squeezing the pistol lever.

 It is strongly forbidden to carry out any operation with the machine if you are not wearing the appropriate safety equipment (protective glasses, gloves, overalls etc) as per established safety norms.

 During winter, and in the event of frost, it is advisable to use anti-freeze or to empty out the water from the internal circuits by closing the tap from the water supply and activating the machine until all of the water is expelled.

 Should the machine remain inactive for extended periods of time, it is possible that calcium deposits can form in the valves which can then cause problems when trying to re-start the machine. Should this happen, pay particular attention to any strange or unexpected noises emanating from the machine, in which case you should consult your local technical services.

IMPROPER USE

By improper use, we mean using the machine for uses which it was not specifically designed for, such as:

- Washing of objects or vehicles which have come into contact with inflammable or noxious dust, gas or liquids, or substances which can cause dangerous reactions when in contact with water.
- Use of the machine in places where there is a danger of explosions, or a significant risk of fire.
- Use of the machine for the cleaning of animals, of any size.
- Use of the machine by anyone under the age of 16 years.
- Use of the machine in the rain or during thunderstorms.
- Use of the machine for the washing of any equipment supplied by an electric current.
- Use of the machine by anyone unauthorised personnel, or anyone untrained to do so.

ERRONEOUS USE

By erroneous use, we mean the use of our machine without respect for the guidelines contained in the instruction and maintenance manual. Lack of respect for these guidelines can represent a risk of injury to both the operator and those persons nearby as well as a risk of serious damage to the machine itself.

Erroneous use, therefore, can constitute: unsecured connections (including those of accessories supplied as optional extras), not using original spare parts, repairs undertaken by unauthorised or unqualified personnel, use of the machine for purposes it was not designed for (see improper use), lack of proper maintenance and use of the electrical power supply cable or the high pressure tube to drag or haul the machine around.

USAGE IN ENCLOSED AREAS

Where the machine is to be used in an enclosed area, you should attach the chimney adaptor, our order code VTRPS5000030.

ATTENTION:

The diameter (z) of the chimney (2) must not be less than that of the adaptor (1). It is advised to take steps to install a chimney to expel the machine fumes, as shown in the diagram.

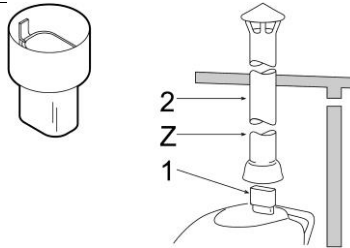
**Usage in areas subject to winds or strong air currents****ATTENTION:**

Where the machine is to be used in areas subject to wind or strong air currents, you should attach the chimney adaptor, our order code VTRPS5000030. This simple precaution will help avoid serious damage to the machine.

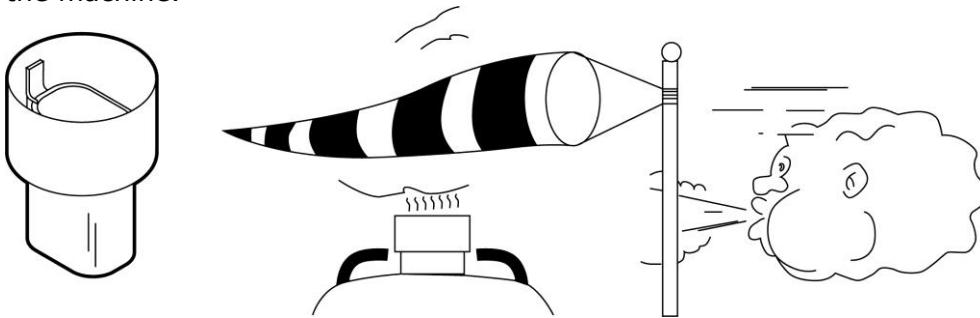

This simple precaution will help avoid serious damage to the machine.

PRECAUTIONS

Before activating the high pressure cleaner, make certain that the water supply is correct (min. 1 Bar – Max 8 Bar); dry use can provoke serious damage to the machine's waterproofing systems.

To safeguard the security of the operator and of the machine, avoid making modifications to the machine without the written consent of the manufacturer.

If you notice any damage to the machine, refrain from any and all work with the machine, and immediately inform the re-seller or an authorised technician.

During use, avoid covering the machine: if you consider it necessary to protect the machine, do it in such a way as to allow air to circulate freely in order to cool the motor.

In the event of a long pause / break during work / using the machine (more than 15 minutes), turn off the machine and release the residual pressure.

The maintenance of this machine requires the use of a qualified person who, as well as having knowledge of this instruction manual, should be equally familiar with general safety guidelines as well as those measures specific to this machine.

For matters of repair, maintenance and tuning, we always recommend that you refer to a re-seller or authorised technician.

ATTENTION:

Never under-estimate these warnings, use of the machine in an inappropriate manner, can lead to serious damage and injury to the operator and any surrounding personal. Don't take risks!

ATTENTION:

The manufacturer cannot be held responsible for any eventual damage or injury to people, animals or property resulting from improper or unreasonable use, or usage in any way not conforming to the instructions contained in this manual.

TECHNICAL DATA:**Industrial Specification – VTS**

Rapid Mobile Model:	VTS15200HPC	VTS240HPC	VTS415HPC
Water Flow(Litres per minute):	15	12	15
Pressure (Bar/Psi)	200	100	150
Motor Power (HP @ 1400rpm)	7.5	3	5.5
Chemical Feature	H.Press.	H.Press.	H.Press.
Run System protection	Auto Stop/Start with 1 hour shut down	Auto Stop/Start with 1 hour shut down	
Water Temperature	0-150°C	0-150°C	0-150°C
Power supply (Voltage)	415v	240v	415v
Weight	120kg	110kg	110kg
Dimensions (L x W x H) cm	100 x 67 x 87cm	100 x 67 x 72cm	

IDENTIFICATION DATA

The position of the identification data of the machine

1) Identification of the machine according to EU directives.

V-TUF®	CE	91
Great Britain	95	
Model / Modello	Rapid Mobile 1	
Type / Tipo	R 1200	
Serial No. / Numero di serie	90096	
Lot production / Lotto	0078	
Working pressure	120 bar	
Pressure / Pressione	120 bar	
Flow rate / Min. / Max.	58 / 145 l/min	
Power / Potenza	1.5 kW	
Temp. Max. Allowable	35 °C	
Water supply / Ingresso acqua	3/4" G	
Temp. Max. Water Supply	140 °C	
Motor / Motore	1.5 kW	
Number of G.P.M.	1400 RPM	
Frequency of rotation	30 Hz	
Voltage / Tensione	240V 50-60 Hz	
Max pressure	1800 psi	
Pressure / Pressione	120 bar	
Capacity	2.5 l	
Weight	4.5 kg	
Border Output/Pressione Carica	50 bar	



ATTENTION:

Check that your RAPID-VTS high pressure washer has been provided with these identification details, if they have not been provided please inform your local dealer immediately.

Machines which have not been provided with these details **MUST NOT BE USED**, and should be considered anonymous and potentially dangerous.

It is obligatory that you ensure that the data label is always attached to the machine and clearly legible.

In case of damage, loss or illegibility, you should submit a written request to the manufacturer who will then provide you with a new one.

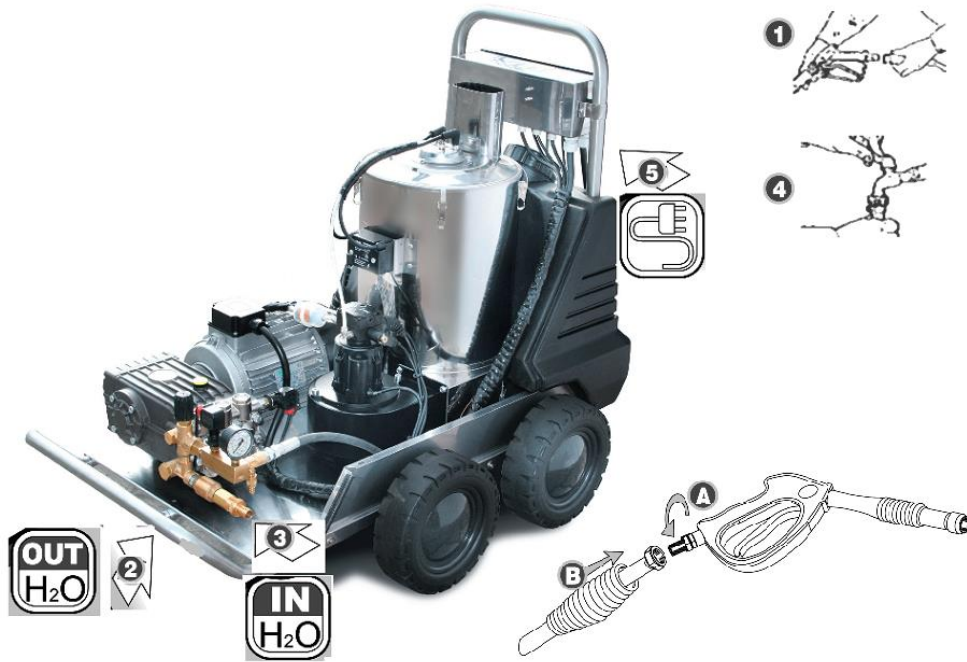
INSTALLATION

Attach the lance to the high pressure hose (1) and the other end to the output connection (2). Fit the sheath (B) in order to protect the hydraulic connection and to avoid the risk of scalding by contact. The high pressure pump is supplied already full of lubricating oil. Attach a water tube (not supplied) to the entry connection (3) and the other end to the tap of the water source (4) which must be able to provide a minimum flow rate equal to that of the pump.

Check that the electric supply socket has the appropriate characteristics and differential protection, and conforms to safety standards in force, then insert the plug into the power socket. Wherever possible, avoid the use of extension cables with the electrical supply cable.

ATTENTION

The electrical power supply should be provided by a magneto thermic switch adequate to the power of the machine.

Also, there should always be installed a high sensitivity differential switch with a cut-off threshold of $I_{dn}=0.030$ A.

It is necessary that the machine is earthed in such a way as to guarantee a contact voltage of no more than 25V.

Operation of the machine should be carried out in such a way that damage cannot be caused to people or property and, wherever possible, away from paths of transit.

COLD WATER USE

1. Check that the warning light (c) is lit, indicating that there is electric current within the machine.
2. Open the water source tap (2), then start the motor and pump by pressing the appropriate switch (in) on the control board. This will light the relevant light (a).
3. Squeeze the pistol lever (3) to obtain water flow to the lance (4).

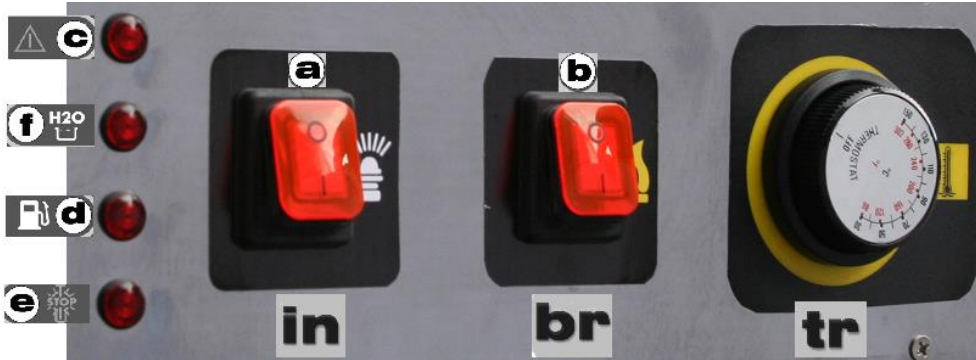

HOT WATER USE

Check that the diesel tank is full (1); if it is not, refill it using exclusively automotive diesel. Repeat points 1 and 2 as per cold water use.

Check that the thermostat (tr) is positioned at 0°C, start the boiler by means of the appropriate switch (br) which will cause the relevant light to illuminate (b), wait for 30 seconds so that the diesel pump can refill, turn the knob of the thermostat (tr) to the required temperature (upon reaching the desired temperature, the burner will cut off automatically to then restart upon any lowering of temperature. Squeeze the pistol lever (3) to obtain water flow to the lance, adjust the lance nozzle accordingly to control the outflow (4) and then start your job.

To close down the machine, turn the thermostat (tr) to zero, keep the pistol open (3) and allow the water to cool, turn off the boiler (br) turn off the water supply (2), turn off the motor and pump (in), then squeeze the pistol lever (3) until the residual water pressure has been expelled.

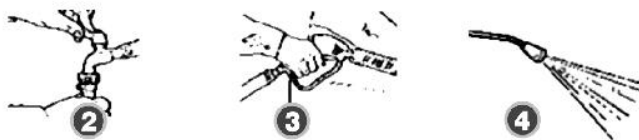

ATTENTION

In case of lack of diesel the electrovalve will close, the fumes will be expelled from the furnace, the boiler will shut down and the relevant warning light will illuminate (d): Shut down the machine, refill the fuel tank (1) and reset the machine by pressing the switch (in).

ATTENTION

In case of lack of water the machine will shut down and the warning light will illuminate (f). Check the connection to the water supply (2) (low pressure circuit) and reset the machine by pressing the switch (in).

ATTENTION

The machine is equipped with the TST (time-delayed auto stop/start) system which will stop the machine 15 seconds after the water pistol is released and will cause the warning light (e) to illuminate.

ATTENTION**TSI SYSTEM**

If a water leak is detected, the machine will shut down and the appropriate warning light (f) will illuminate: check the high pressure water circuit in the machine and then reset the machine by pressing the switch (in).

**ATTENTION
TSI SYSTEM**

The machine is fitted with the TSI (Intelligent Total Stop) system which will cause it to shut down 40 minutes after the water pistol is released. The warning light (e) will illuminate. Reset the machine by pressing the switch (in).

USE WITH CHEMICAL PRODUCTS

With the machine shut down, act the device (adjustable head) placed on the lance end to obtain the suction and the distribution of the product; pull the gun trigger to obtain the detergent distribution and start the work.

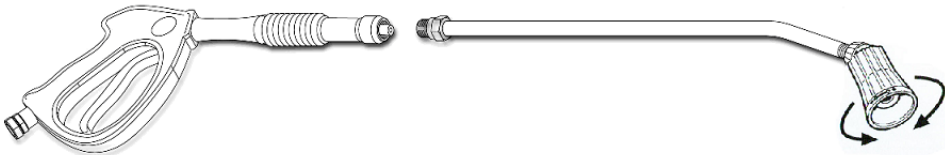
**ATTENTION**

During operation of the machine, it is obligatory to use the appropriate personal safety equipment. During operation, please pay close attention to the information quoted on the chemical product labels regarding safety and the proper percentages to be used when diluting chemicals.

Fill the detergent tank (5) with the product you intend to use for your work and insert the detergent hose suction.



Repeat actions 1, 2 and 3 as per cold water use.

During operation, the detergent will be sucked up and automatically mixed with the water.

Practical Advice

Avoid soaking with water the surface you then wish to treat with detergent because, in doing so, you can place a film of water over the area you wish to treat, resulting in poor cleaning results. Instead, whilst holding the nozzle pointing towards the ground, wait until the detergent exits the nozzle. When the detergent exits the nozzle, approach the surface you wish to treat, start from the bottom with overlapping strips until you reach the top of the area, sprinkling the whole area with detergent. This system is known to avoid dripping of detergent onto dry surfaces, the residue of which could remain even after rinsing. In order to avoid the formation of deposits or crusts, at the end of operation it is advisable to pass clean water through the pump for a few seconds.

Important Advice

To safeguard the environment, we advise that only authorised detergents are used, that the recommendations of use and dosage are observed on the product labels, that detergent is used sparingly and remember that use of inappropriate detergent, as well as damaging the environment can damage the hot water cleaner as well as the objects being cleaned.

USE DETERGENTS WHICH ARE OVER 90% BIODEGRADABLE.

Before sprinkling detergent over varnished areas with delicate colours, make sure that the surfaces to be treated are not hot, that the detergent has not dried and that the concentration of water / detergent is correct.

IMPORTANT: Rinse well.

Upon completion of operation, shut down the machine then squeeze the pistol lever until the residual water pressure has been expelled.

LUBRICATION OF THE PUMP

For the models 100.12 and 150.15 we recommend:

PL100 LUBE – OIL CAPACITY 0.42 kg

You should change the oil after the first 50 hours of use, and after each subsequent 500 hours of operation.

TRANSPORT – LIFTING – SHIFTING

ATTENTION:

Whenever the machine needs to be transported, it should be securely fixed with straps, cables or other suitable equipment in order to avoid accidental movement which could cause damage to people or property as well as to the machine itself.

ATTENTION:

Should the machine need to be lifted, it should be hooked or coupled by means of strips, or suitable lifting equipment which will safeguard the machine's integrity. Make certain that the lifting equipment used has superior capacity to the weight and volume of the machine; the use of equipment conforming to current applicable safety standards is recommended.

ATTENTION:

It is strictly forbidden to remain under or in the immediate vicinity of the machine while it is being lifted or elevated.

Do not trust crushed or bent chains or straps, always use thick working gloves.

Chain or strap fixtures should always be welded in place.

Check that the attachment is sufficiently robust to sustain the weight.

ATTENTION:

Should the machine need to be shifted manually from one place to another, you should ensure that the power plug has been detached from the electric current, then using the appropriate grip and taking care not to make any sudden movements which could compromise your safety, or that of the integrity of the machine itself, proceed with the moving.

Remember that you must not drag or haul / move the machine by its electrical power supply cable or by the high pressure hose. Use the handles built on the machine.

N. B.

For all further things which have not been specified, please abide by general norms for the prevention of injuries.

STORAGE

Park the machine on a flat surface. If the machine is not going to be used for an extended period of time, empty the water circuits and the fuel tank then cover the machine and store it in a place protected from atmospheric extremes.

SCRAP AND DISPOSAL

Should you decide to scrap the machine, we recommend that you render it inoperative using the following procedure: remove from the machine the electrical power supply cable and water supply tubes; cut the power supply cable and tubes; remove the lance and pistol, cut all of the electrical cables, break the pump and the motor, destroy the identification data label of the machine and also those of the pump and motor group.

Please remember that the chemical products contained inside the machines tubing should be removed in advance; if necessary any containers used for this purpose should be recycled or disposed of as per current laws in force.

PACKAGING

The packaging materials should be gathered together and sent to a company specialising in the disposal of refuse (wood, plastic, metal etc.) and not left within reach of children or animals.

REGULATION OF THE STARTER ELECTRODES

For optimum machine performance, it is necessary to check that the starter electrodes are always arranged in the correct way, as indicated in the diagram.

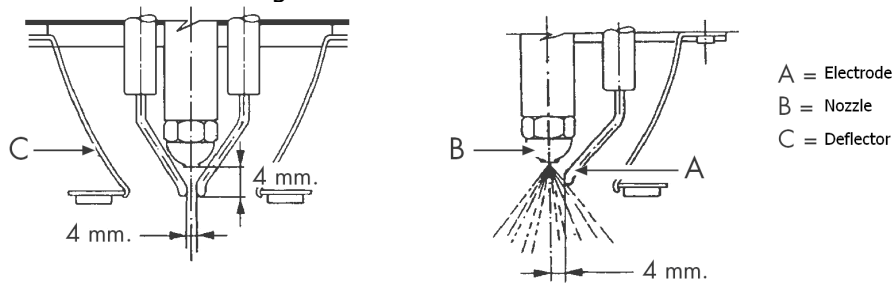

Checking the height in relation to the level of the head of the fuel nozzle.

Resting the control bar on the head of the diesel nozzle, as indicated in the diagram, check that the two electrodes do not go beyond the main wire.

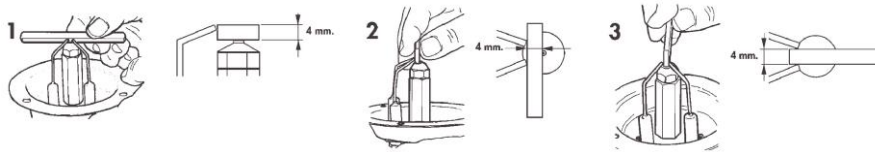

ATTENTION

This work should be undertaken by an authorized technician.

The starter electrodes should be replaced after every 400 hours of operation.

Checking the distance between the electrodes. Resting the control bar on the head of the diesel nozzle, as indicated in the diagram, check that the two electrodes are both in contact with the surface of the control bar.

Checking the distance between the electrodes and the centre of the head of the diesel nozzle. Resting the control bar on the head of the diesel nozzle, and keeping its internal surfaces in the centre, as shown in the diagram, check that the two electrodes are in contact with the external surface of the control bar.

It is recommended that you always check with your re-seller, nearest help centre or qualified and authorized technician regarding maintenance details, repairs and / or adjustments. The manufacturer does not accept any responsibility or liability for any damages caused by use of the machine with parts which are not perfectly regulated, or with parts which are damaged or worn out.

Cleaning of the hot water high pressure cleaner

Wash only with neutral products and water: then dry carefully so that you eliminate any collections of water.

The plastic parts can be cleaned with a normal wash. Should any traces of dirt remain, it is recommended that you use specific products, carefully observing the usage instructions.

ATTENTION

Do not use products containing solvents, methanol or hydrocarbons.

Troubleshooting

PROBLEMS	CAUSES	SOLUTIONS
The machine turns itself off and warning light D illuminates	Lack of diesel. The plastic joint between the pump and the burner motor is worn out. The fuel pump is worn out The burner motor is not working	Refill the fuel tank Replace fuel pump joint, fuel pump or burner motor, reset machine pressing (IN)
The machine turns itself off and warning light F illuminates	Not enough water The water supply tap is closed Entry to the water filter is obstructed	Make sure that the machine has a water supply with a flow rate higher than that of the pump. Check and open the tap Check and clean, then reset (IN)
The machine turns itself off and warning light E illuminates	Water leaks detected After an hour of total stop, the machine will shut down completely.	Check that there are no leaks in the machine's hydraulic circuit; repair or replace any defective parts. Reset the machine (IN) Reset (IN)
The pump turns but does not reach the required pressure	The pump is sucking in air. Worn out valves Worn out valve seat Worn out or inadequate water nozzle Worn out gaskets Dirty water filter	Check that the piping is watertight Replace the valves Replace the valve seat Replace the water nozzle Replace the gaskets Clean the water filter
Irregular fluctuations in pressure	Worn out suction and/or delivery valves Presence of foreign bodies in the	Replace the valves Check and clean

<p>Drop on pressure</p>	<p>valves which can affect their performance Air being sucked in Worn out gaskets</p> <p>Worn out suction and/or delivery valves Presence of foreign bodies in the valves which can affect their performance Air being sucked in Worn out gaskets</p>	<p>Check the piping Replace the gaskets</p> <p>Replace the valves</p> <p>Check and clean</p> <p>Check the piping Replace the gaskets</p>
<p>Pressure in order on gauge, loss of pressure</p>	<p>Worn out water nozzle. Crust deposits in the circuit</p>	<p>Replace the nozzle</p> <p>Check and clean; we advise contacting one of our technicians.</p>
<p>The boiler is producing excessive amounts of fumes</p>	<p>Presence of water in the fuel tank. The fuel pressure is not correct</p> <p>The starter electrodes are not positioned correctly.</p> <p>The fuel nozzle is dirty The fuel nozzle is worn out The boiler coil is blocked The fuel pump is dirty The fuel electrovalve is not working.</p>	<p>Empty the fuel tank, and refill with clean fuel. Restore the correct pressure, turning the appropriate screw in order to reach approximately 10 Bar.</p> <p>Check the distance of the electrodes.</p> <p>Clean the fuel nozzle Replace the fuel nozzle Clean the boiler coil Clean the fuel pump Replace the fuel electrovalve.</p>
<p>The boiler switches itself off.</p>	<p>The fuel tank is empty. The filter on the fuel suction tube is dirty. Presence of water in the fuel tank. The pressure switch is not working. The starter transformer is broken. The starter electrodes are not positioned correctly. The fuel nozzle is dirty. The fuel nozzle is worn out. The fuel pump is damaged.</p>	<p>Refill the fuel tank. Clean the fuel filter. Empty the fuel tank, and refill with clean fuel. Replace the pressure switch. Replace the starter transformer. Reposition the starter electrodes into the correct position. Clean the fuel nozzle. Replace the fuel nozzle. Replace the fuel pump.</p>

	The fuel electrovalve is damaged.	Replace the fuel electrovalve.
Presence of water in the pump oil	Worn out oil seal. High percentage of humidity on the air. Gaskets are completely worn out.	Replace the oil seal. Change the oil twice as often as is normally prescribed. Replace the gaskets.
Excessive noise	Air is being sucked in. Dirty water filter Insufficient water supply. The springs on the suction and/or delivery valves are worn out or broken. Foreign bodies in the suction and/or delivery valves. Worn out ball bearings. The temperature of the water being pumped is excessive.	Check the seals in the tubing. Clean the water filter. Check that the machine has a water supply superior to the flow rate of the pump. Replace the valves. Check and clean the valves. Replace the ball bearings. Lower the temperature of the water being pumped.
Water discharge from between the pump body and the pump head.	Worn out gaskets. Worn out pistons. OR piston plug is worn out.	Replace the gaskets. Replace the pistons. Replace the OR piston plug.
Oil discharge from between the pump body and the pump head.	Worn out oil seals.	Replace the oil seals.
Excessive vibrations.	Worn out or dirty valves.	Replace the valves.

<p>The electric motor does not start.</p>	<p>There is no electric current. The magnetothermic switch is released.</p>	<p>Check that the plug is securely inserted into the socket and that there is current present. Open the electric control panel and check the magnetothermic switch.</p>
<p>Insufficient water temperature.</p>	<p>Thermostat not positioned to required temperature.</p> <p>The thermostat is broken. Crust build-up on the hydraulic circuit. Soot build-up may be partially blocking the boiler. The water nozzle is worn out.</p>	<p>Position the thermostat to the required temperature.</p> <p>Replace the thermostat. Clean.</p> <p>Clean.</p> <p>Replace the water nozzle.</p>

HYDRAULIC DIAGRAM

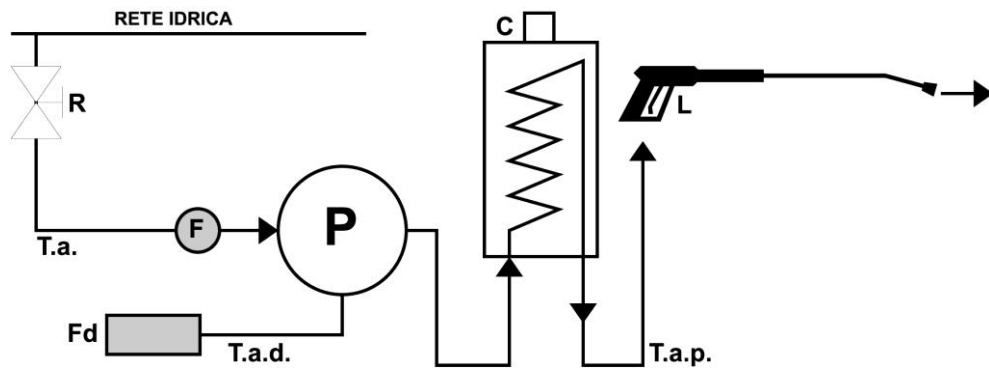

- R = Water Tap
- T.a. = Water Suction Tube
- F = Filter
- Fd = Detergent Filter
- T.a.d. = Detergent Suction Tube
- P = Water Pump
- t.m. = Delivery Tube
- c = Boiler
- t.a.p. = High Pressure Water Outlet Tube
- l = Lance

ELECTRIC DIAGRAM - SINGLE PHASE 230V

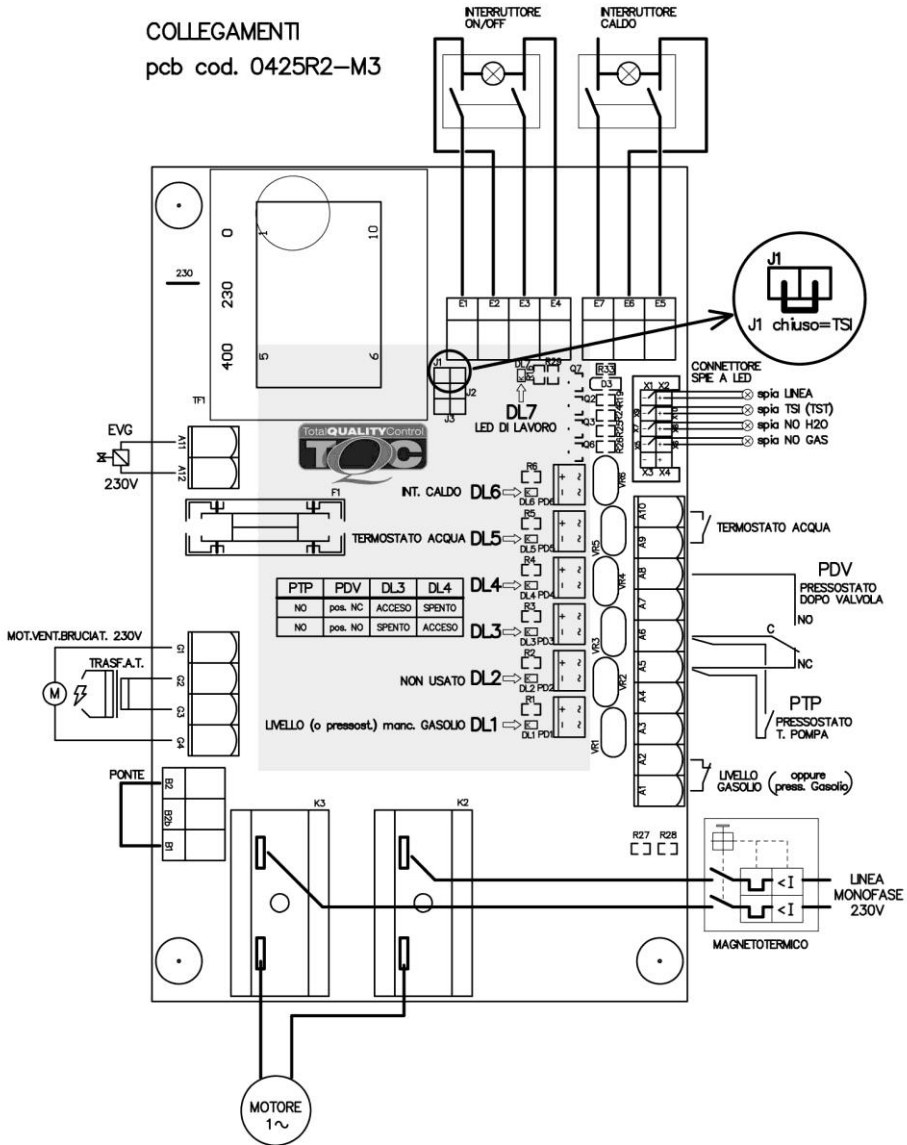

ELECTRIC DIAGRAM – THREE PHASE 230V

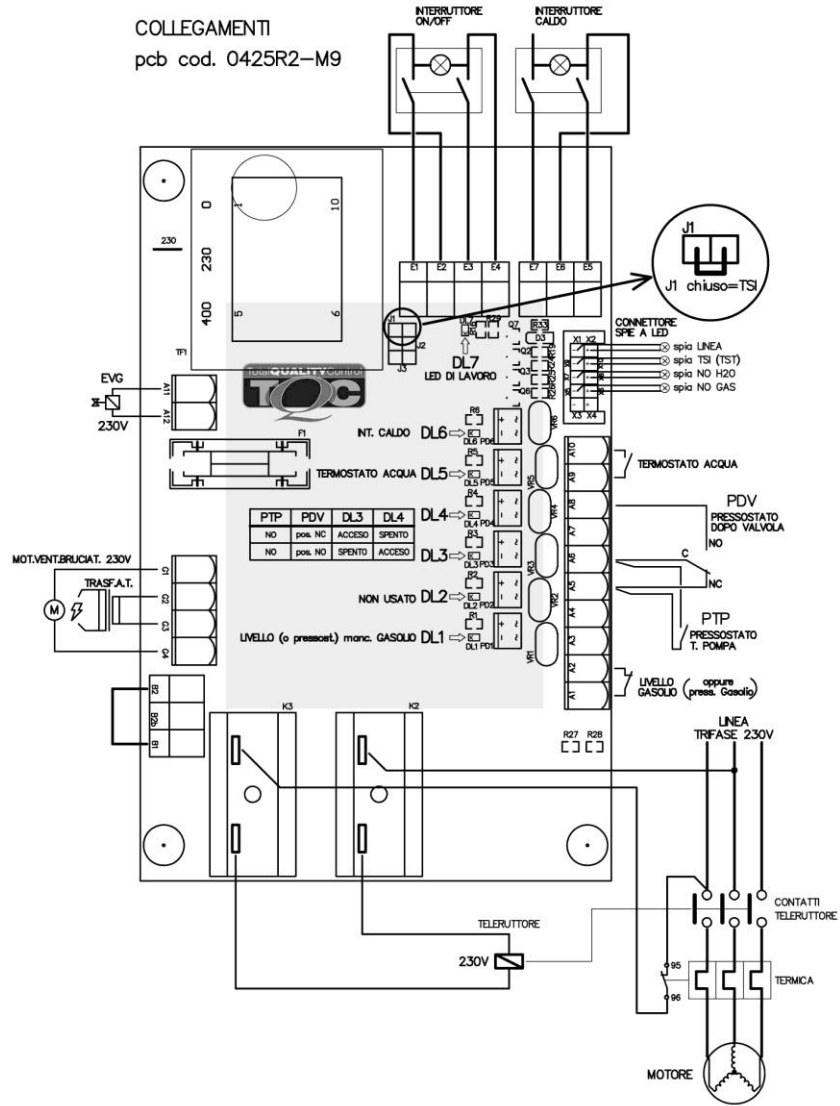

ELECTRIC DIAGRAM - THREE PHASE 400V

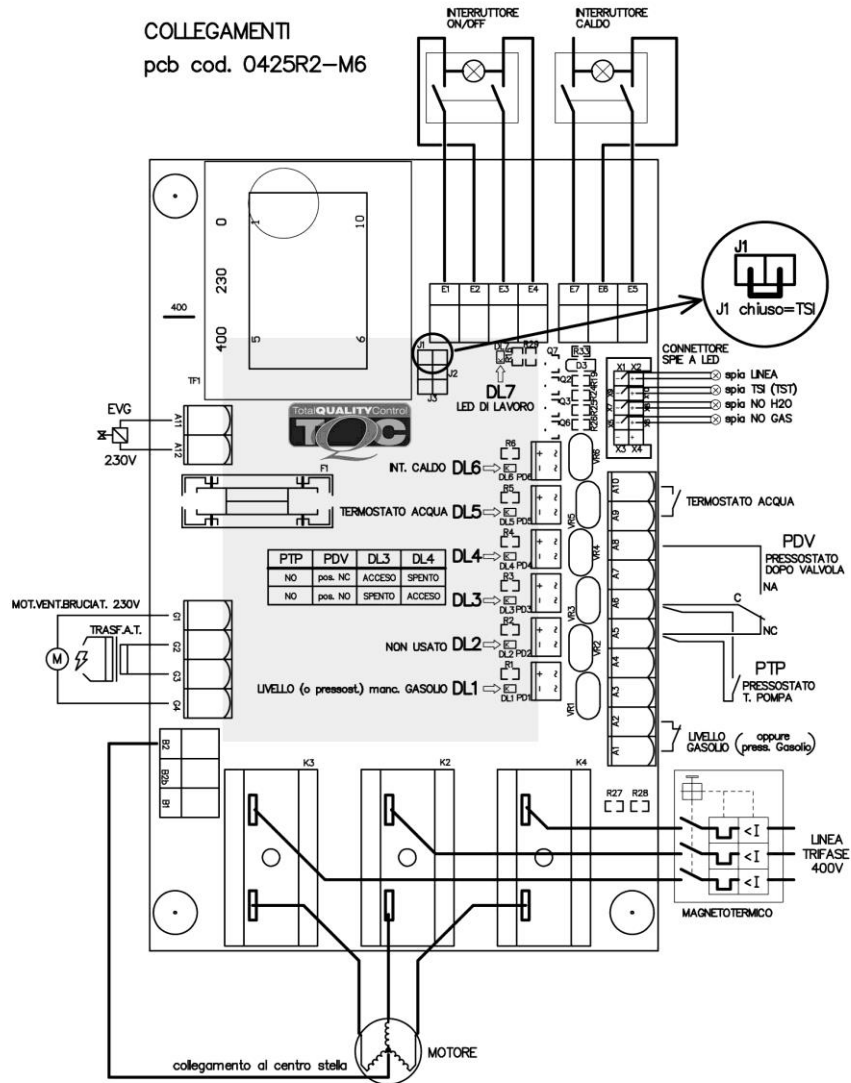

Functionality:

The high pressure water cleaner has an input for an On/Off switch for the machine, a switch to select between hot or cold water operation, a "diesel pressure switch" input to manage the lack of diesel, and an input for the water temperature thermostat and 2 inputs for the pressure switches PTP and PDV.

- PTP = Pump head pressure switch
- PDV = Valve pressure switch
- PPG = Diesel pump pressure switch

3 outputs for the running of the electrovalve, diesel motor and the burner / ventilator

- MOT = Pump motor
- BV = Burner / ventilator
- EVG = Diesel electrovalve

And finally 4 outputs for the light showing electric current, the TSI light, the light for lack of water and the lack of fuel light.

S_LIN = Electric current light
S_TSI = TSI LIGHT (Total Stop)
S_H2O = Lack of water light
S_GAS = Lack of fuel light

Running

Connecting to the electric current, the current light illuminates.

Pressing the ON/OFF button to On will start the machine which will run accordingly:

STATE1

PTP->NO (0 Bar)
PDV ->NC (0 Bar)

High pressure water cleaner "closed down"

STATE 2

Pistol (lance) open
High pressure water cleaner "in operation"
PTP->NC (200 Bar)
PDV->NO (200 Bar)
MOT=ON
BV= On after 1 second (*)
EVG= On after 3 seconds (**)

STATE 3

Pistol (lance) closed
PTP->NO (0 Bar)
PDV->NO (200 Bar)
EVG= OFF (**)
BV= Off after 14 seconds (*)
MOT= Off after 14 seconds
S_TSI= On after 14 seconds

To restore the TSI system, it is necessary to verify the conditions of state 1 (pistol/lance open) followed by state 2 etc..

The machine also manages the lack of fuel (PPG), 14 seconds after detection the EVG (**) and the BV (*) will switch off. 1 second later the relevant warning light (S_GAS) will illuminate and the system will be blocked.

To restore it, you must shut the machine down and turn it on again.

The machine is also supplied with a time-out feature so that if the machine is not used for 40 minutes, it shuts itself down and the machine is blocked (shown by the TSI light illuminating). To restore normal operation, it is necessary to turn the machine off and start it up again.

Finally, the machine is equipped with a particular algorithm for recognising water leaks so that if it should detect 10 consecutive drips in less than 3 seconds, the machine will shut down and the TSI light will illuminate. To restore operation it is necessary to turn the machine off and start it up again.

(**) EVG works only in hot water mode, with the water temperature thermostat.

(*) BV works only in hot water mode, independently of the water temperature thermostat.

PUMP-MOTOR-VALVE PARTS DIAGRAM & LIST

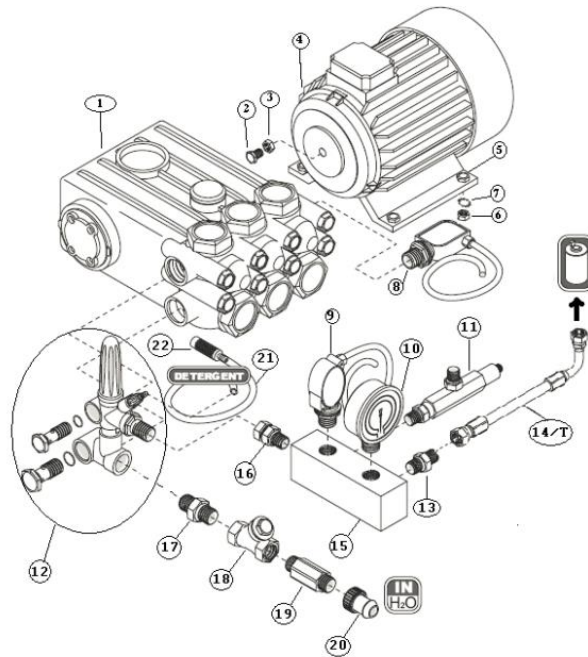

Item	Code	Description	Qty	Item	Code	Description	Qty
			1	12	C0.0611/VTPS	BY-PASS CONTROL SET W3 (for W Pump)	1
1			1	12	C0.0611/VTPS	VB75 VALVE (for XM PUMP)	1
1	XHDM300	XHDM300 (240V) PUMP	1	13	MB6	3/8 MxM BSP ADAPTOR	1
1	XHDM350	XHDM350 (415V) PUMP 150BAR	1	14/T	6125010	Ø80 HOSE	2
1	XHDM400	XHDM400 (415V) PUMP 200BAR	1	15	3280029	BRASS CUBE BLOCK	1
2	1000502	TE 8x30 SCREW	4	16	1000223	3/8 M/F ADAPTOR	1
3	1000601	M8 WASHER	4	17	1000430	1/2 MxM BSP ADAPTOR	1
4	MH.243	3HP AC H100 230/50 MOTOR	1	18	1000250	½" Y FILTER	1
4	MH.4155	5.5HP AC H100 400/50 MOTOR	1	19	A1560600	EXTENSION	1
5	1000502FZ	TE 8x30 FL. SCREW	4	20	1000239	¾" x 17 HOSE FITTING	1
6	1000700FZ	M8 FL. NUT	4	21	4000134	7x10 DETERGENT HOSE	1.50
7	1000624	8x24 WASHER	8	22	A1341030	DETERGENT FILTER	1
8	6100140	150 - 170 PRESSURE SWITCH	1				
8	6100141	120 - 130 PRESSURE SWITCH	1				
9	P29008050	PRESSURE SWITCH	1				
10	1000340	MANOMETER	1				
11	6600470	SAFETY VALVE	1				

LUBRICATION OF THE PUMP

We recommend:

PL100 LUBE - OIL CAPACITY 0.42 kg

You should change the oil after the first 50 hours of use, and after each subsequent 500 hours of operation.

FRAME ASSEMBLY PARTS DIAGRAM & LIST

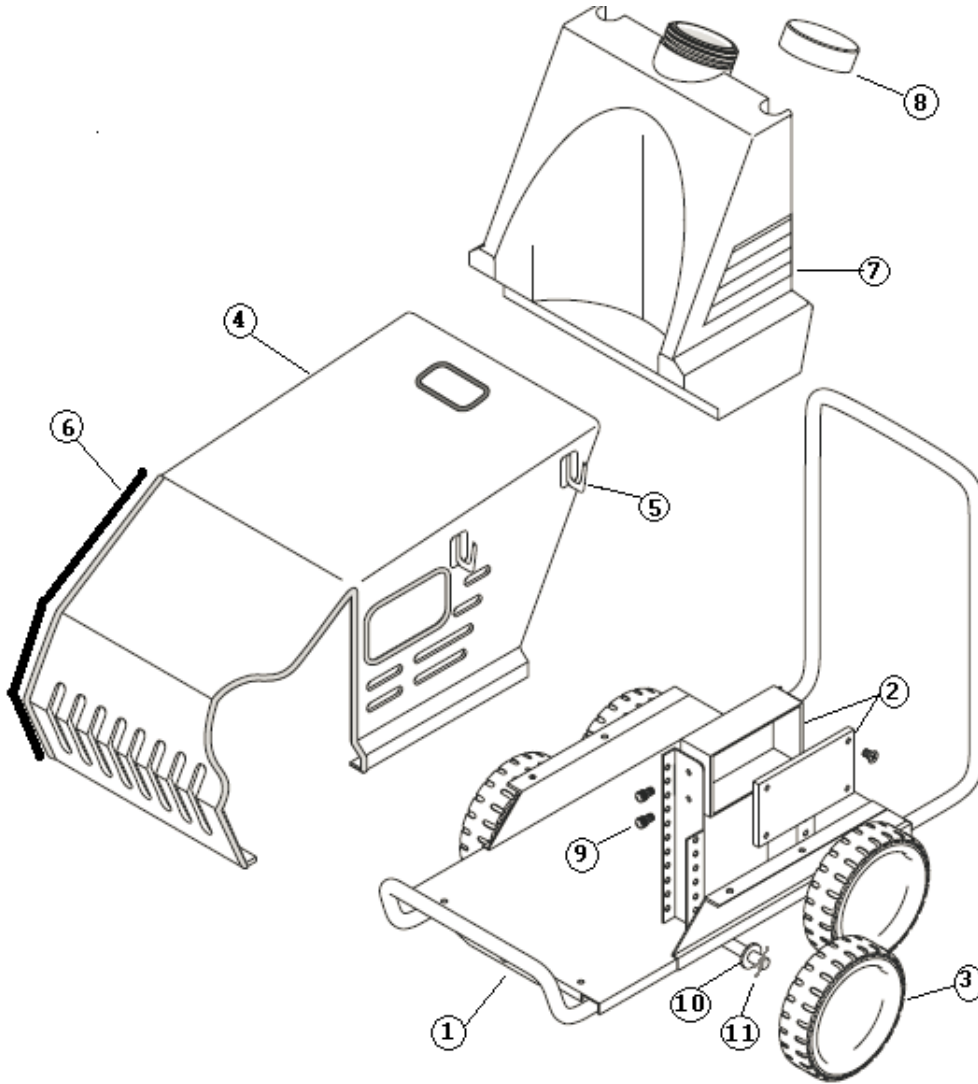

ITEM	CODE	DESCRIPTION	QTY
1	5210000	CHASSIS	1
2	5116010	ELECTRIC BOX	1
3	4400115CPL	HEAVY DUTY WHEEL	4
4	5116011	STAINLESS STEEL COVER	1
5	4000085	LANCE HOLDER	3
6	4000080	RUBBER EDGEING	3M
7	4100010	FUEL TANK	1
8	4100011	FUEL LID / CAP	1
9	1000540/1	5x10 SREW	4
10	1300200	M20 WASHER	1
11	1300440	4x40 SPLIT PIN	4

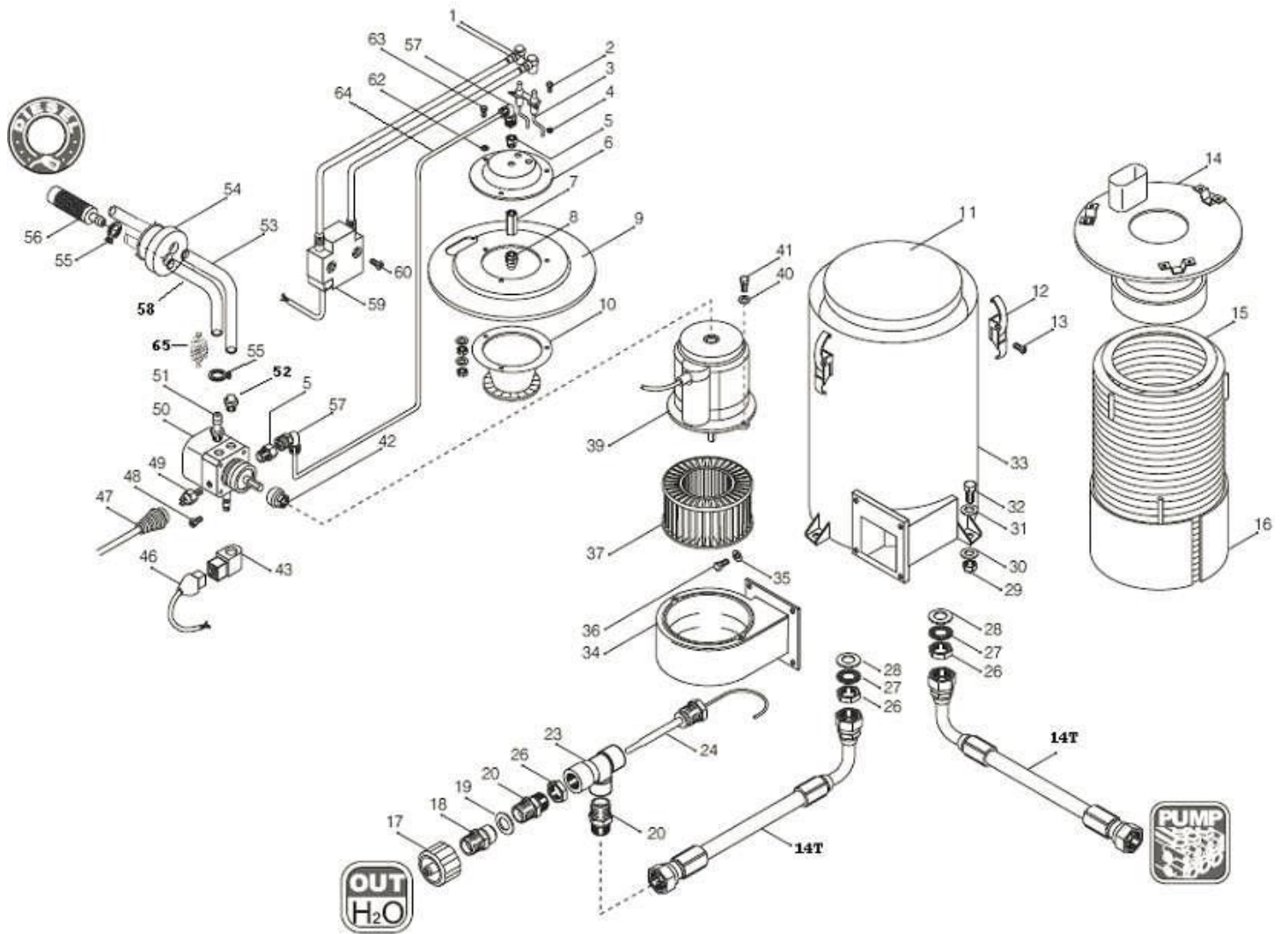
BOILER PARTS DIAGRAM

BOILER PARTS LIST

ITEM	CODE	DESCRIPTION	QTY
1	B5.0321	IGNITION CABLE	2
2	1000521	M4 x 8 SCREW	2
3	D6.030	ELECTRODE	1
4	1000740	M4 NUT	2
5	1000230	1/8MF EXTENSION	2
6	3000040	ELECTRODE HOLDER	1
7	1000220	FUEL INJECTOR HOLDER	1
8	T6.1.3580H	FUEL INJECTOR	1
9	3000030	UPPER TOP COVER	1
10	3000050	DEFLECTOR	1
11	4000280	LID	1
12	1000050	LEVER	4
13	1000080	RIVETS	8
14	3125030	LOWER TOP COVER	1
14T	6200105 + 6125010	BOILER HOSE	1
15	3000065	COIL	1
16	3100060	STAINLESS STEEL RING	1
17	1000285	MVG8 QUICK COUPLING	1
18	1000281	MVG06 QUICK CONNECTOR	1
19	1000619	½" WASHER	1
20	1000211	3/8" /1/2" BSP ADAPTOR	1
23	1000200	½" T ADAPTOR	1
24	6000002	THERMOSTAT	1
26	1000790	½" NUT	2
27	1200600	E20 WASHER	2
28	1000610	M22 WASHER	2
29	1000703	M8 NUT	3
30	1000624	8x24 WASHER	3
31	1000600	WASHER	3
32	1280321	8x20 SCREW	3
33	5100030/X	COIL CASING	1

34	3100020	FAN HOUSING	1
35	1000645	M6 WASHER	4
36	1000510	6x10 SCREW	4
37	3000010	FAN	1
39	6000015	BOILER MOTOR	1
41	1000560	8x16 TCEI SCREW	2
42	4000070	COUPLING	1
43	20000100/D	SOLENOID VALVE COIL	1
46		COIL CABLE	1
47	4000045	PRESSURE SWITCH COVER	1
48	2000445	FASTENER	2
49	6000001	1/8 FUEL PRESSURE SWITCH	1
50	6350011/D	FUEL PUMP	1
51	1000479	HOSE FITTING	3
52	1000216	¼" M 1511 FITTING	1
53	4000120	HOSE	2.5mt
54	4000001	CORK	1
55	1000055	HOSE CLAMP	3
56	A1341030	FILTER	1
57	1000218	1/8M 6/4 1500 FITTING	2
58	4000135	8x12 HOSE	2.5mt
59	2000090	POWER IGNITION TRANSFORMER	1
60	1000546	5x50 TC SCREW	2
62	1000655	M5 LARGE WASHER	2
63	1000513	6x20 SCREW	3
64	4000120	FUEL HOSE PIPE	0.7mt
65	E6.301	FUEL FILTER	1
66	4110060	DIESEL LABEL	1

ELECTRIC BOX PARTS DIAGRAM

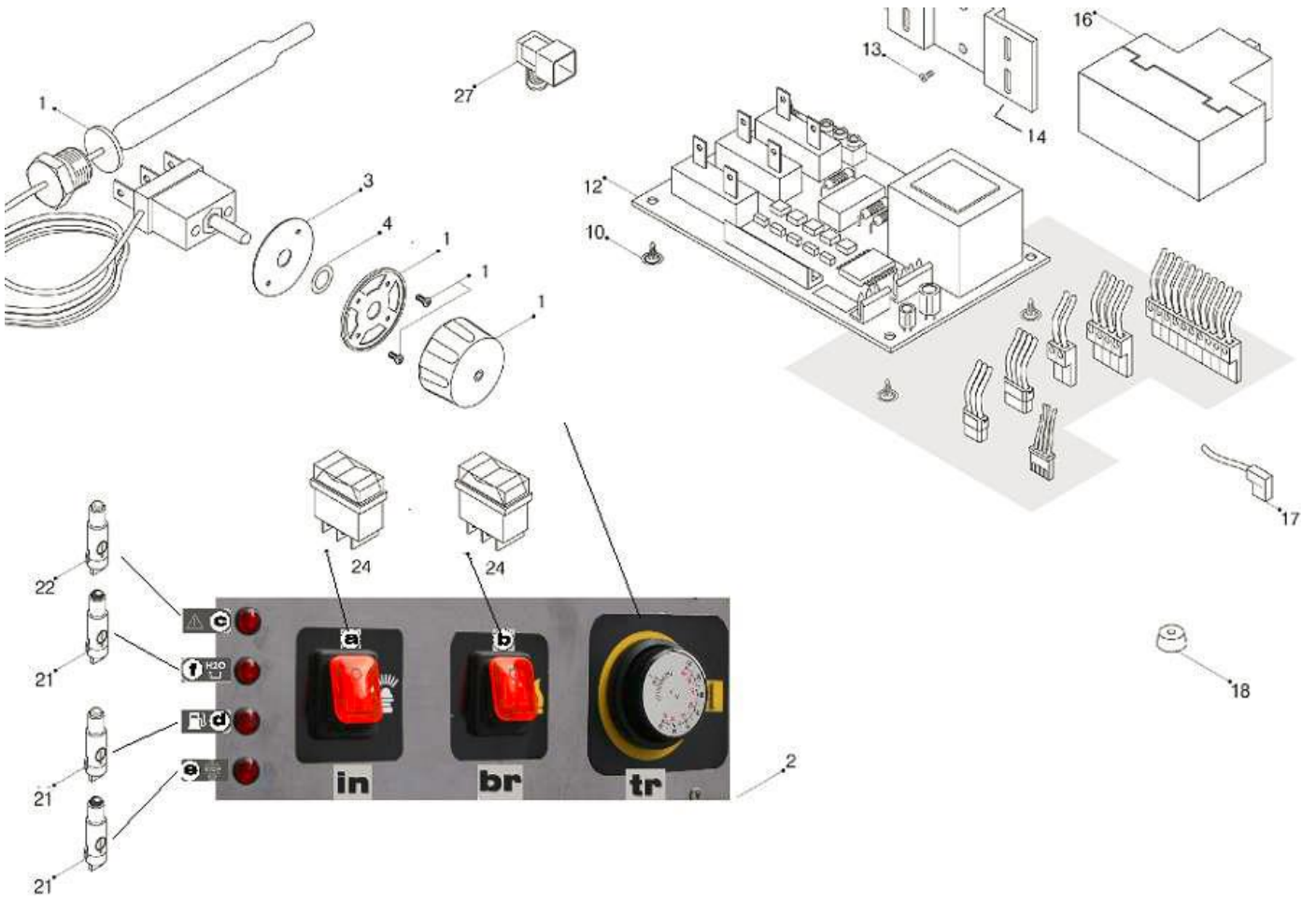

Item 2:

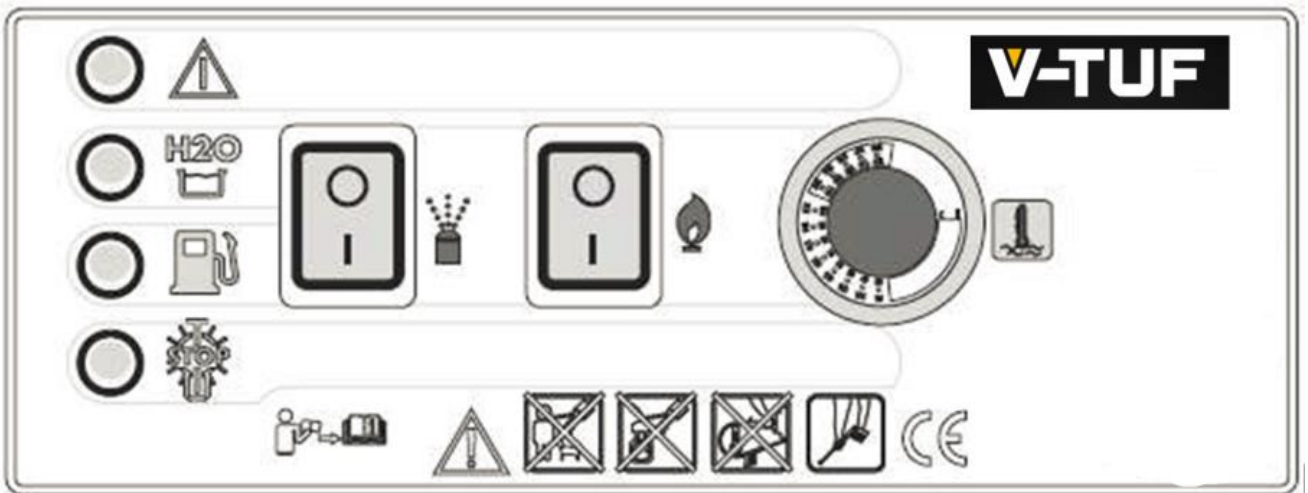

ELECTRIC BOX PARTS LIST

ITEM	CODE	DESCRIPTION	QTY
1	19.5110	THERMOSTAT	1
2	4280030	CONTOL PANEL LABEL	1
3	4600021	GASKET	1
4	4600022	O-RING	1
10	4000083	SPACER	4
12	2000113T	400V/ PCB BOARD	1
12	2000113M	230V / PCB BOARD	1
13	1000532	TAPPING SCREW	2
14	5400065	BRACKET	1
16	A1382060	CIRCUIT BREAKER	1
17	2000446	TERMINALS	1
18	4100044	PLUG WIRE THERMOSTAT	1
21	I2.084	RED LED LIGHT WITH LENS	3
22	I2.085	LED LIGHT WITH LENS	1
24	VTVS7422	24V ON/OFF SWITCH	2
27	2000124	TRANSPARENT TERMINAL	1

ACCESSORIES PARTS & LIST

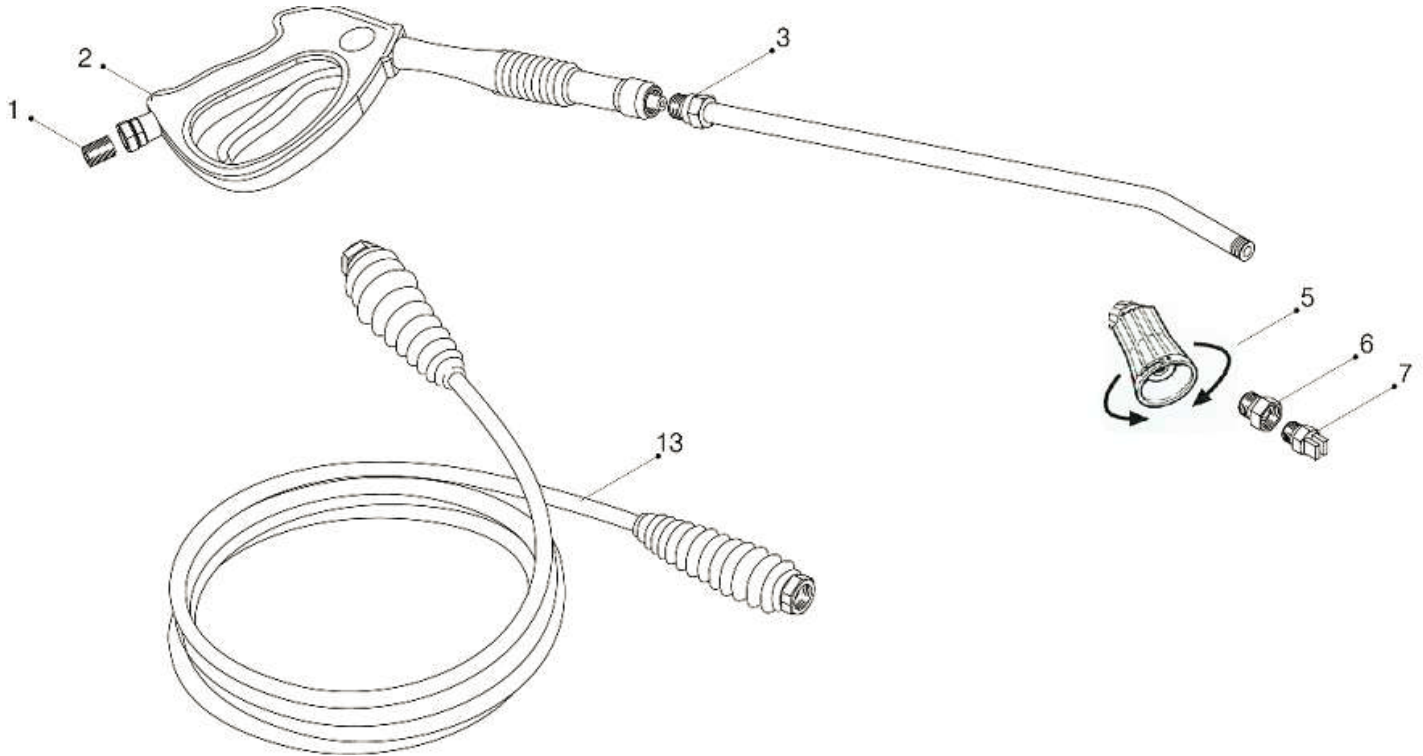

ITEM	CODE	DESCRIPTION	QTY
1 & 2	B14.2114 & T1.085	QR TRIGGER WITH (1) B14.2114 KWIK SWIVEL ADAPTOR	1
3	OPF091	900mm QR LANCE	1
5 & 6	H4.007	ADJUSTABLE VARIO NOZZLE HOLDER	1
7	T15.050J	HIGH PRESSURE JET NOZZLE	1
8	WFK251610FFYK /2xB14.2014	10m HIGH PRESSURE HOSE WITH 2x B14.2014 KWIK SWIVEL F x 3/8M	1

XHDM300/XHDM350 PUMP PARTS DIAGRAM (VTS 240/415)

KIT RICAMBI / PART KITS

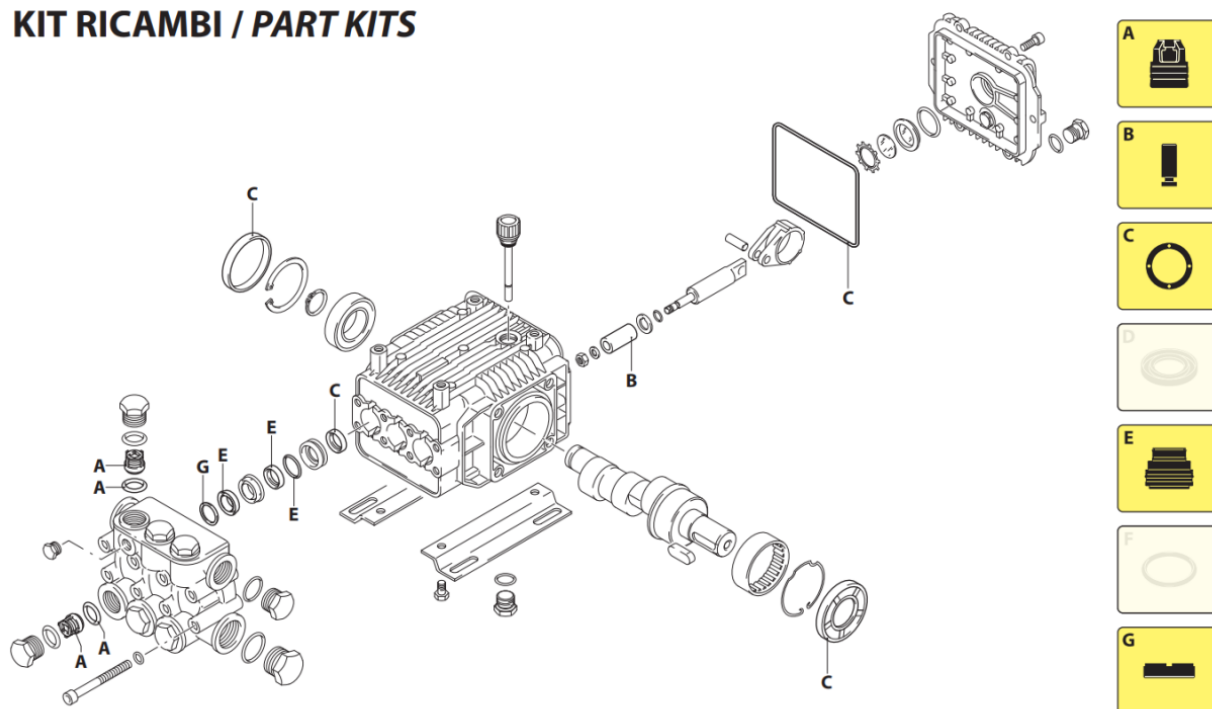

XHDM300/XHDM350/XHDM400 COMMON PUMP PARTS LISTS

ITEM	CODE	DESCRIPTION	QTY
A	VTPS5/6/7003	VALVE KIT	1
A	VTPS4003	VALVE KIT for XHDM400 PUMP	1
B	PISTON3	PISTONS (x3) FOR XHDM300 PUMP 15mm	1 KIT
B	PISTON3A	PISTONS (X3) FOR XHDM350 PUMP 18mm	1 KIT
B	PISTON 4	PISTONS (x3) FOR XHDM400 PUMP 18mm	1 KIT
C	2786	OIL SEAL KIT	1
E	SEAL3	WATER SEALS FOR XHDM300 PUMP	1
E	SEAL3A	WATER SEALS XHDM350 PUMP	1
E	SEAL 4	WATER SEALS XHDM400 PUMP	1
G	2740	SUPPORT RINGS XHDM300 PUMP	1
G	2745	SUPPORT RINGS XHDM350 PUMP	1

V-TUF

GET EQUIPPED

For more details contact us:

UK Head Office:
+44 (0) 1522 787978

V-TÜF
Fenco House
Chris Sharp Building
Till Bridge Lane
Scampton
Lincoln
LN1 2SX
United Kingdom

E-mail: enquiries@v-tuf.com
Web: www.v-tuf.com

Follow us:

